

ORIGINAL INSTRUCTIONS

# OPERATING & MAINTENANCE MANUAL



## PRESSURE CLEANERS

**HP30275P**

**HP23350P**

**HP21250P**

**HP18450P**

*Petrol Cold Water*

*High Pressure Cleaner*

**Made in Australia by:**

Spitwater Australia Pty Ltd T/A Ottico Equipment  
953 Metry Street, Albury NSW 2640 Australia

*spitwater.com*



CREATORS OF

**SPITWATER**



**WARNING:** Read and understand this instruction manual before operating this unit and retain for future reference. Failure to follow operating, safety and maintenance instructions outlined in this manual releases the manufacturer from any responsibility for any accidents or damage incurred and may render any warranty void.

## INTRODUCTION

Spitwater Australia is proudly Australian owned and operated since 1982. Our promise is to provide our customers with superior quality high pressure cleaners built to the highest of standards that will see many years of reliable service.

The Spitwater range of high-pressure cleaners has been designed to give safe, efficient and dependable service when the correct operating and safety instructions are followed and proper attention is given to all required maintenance procedures in order to maintain the unit in peak operating condition.

This manual provides the up-to-date information necessary for the user to operate the unit and carry out regular inspection and maintenance.

Please note that the information given within this manual may be subject to revision in compliance with Spitwater Australia's policy of continual improvement.

Spitwater high pressure cleaners should only be used in the manner and purpose for which they were intended and in accordance with the recommendations and safety precautions detailed in this manual.

All Spitwater high pressure cleaners undergo rigorous safety and operational tests before being dispatched into the market, however it is still imperative that prior to use, all operators have read and understood all information and instructions provided and are aware of possible hazards.

## GENERAL DESCRIPTION & INTENDED USE

Spitwater high pressure cleaners are specifically designed to solve all problems relating to washing, degreasing, descaling and disinfecting in a wide range of commercial and industrial situations. Some examples of applications are in the cleaning, building, transport, light and heavy manufacturing and primary industries.

## SPARE PARTS, ACCESSORIES AND AFTER SALES SERVICE

Spitwater has an extensive range of spare parts and accessories to suit all your cleaning needs. For spare parts, accessories and service please contact **1800 SPITWATER (1800 774 892)** and to view Spitwater's extensive range of high-pressure cleaner's online visit **[www.spitwater.com.au](http://www.spitwater.com.au)**

For international spare parts, accessories and service please contact **[enquiries@spitwater.com](mailto:enquiries@spitwater.com)**















## TECHNICAL DATA

	MODEL	HP21250P	HP30275P	HP23350P	HP18450P	
	PRODUCT	SCW002	SCW003	SCW004	SCW005	UNIT
<b>PERFORMANCE</b>						
	FLOW RATE	21	30	23	18	L/M
	PRESSURE	25.5	27.5	35	45	MPa
	PRESSURE	250	275	350	450	BAR
	NOZZLE	055	070	045	035	
<b>WATER INLET</b>						
	PRESSURE MAX	0.8	0.8	0.8	0.8	MPa
	TEMP MAX	40	40	40	40	°C
<b>ENGINE</b>						
	ENGINE MODEL	HONDA GX630	HONDA GX690	HONDA GX690	HONDA GX690	
	TYPE	PETROL	PETROL	PETROL	PETROL	
	SPEED	3570	3570	3570	3570	RPM
	POWER	20	24	24	24	HP
	FUEL CAPACITY	-	-	-	-	L
	STARTING SYSTEM	ELECTRIC	ELECTRIC	ELECTRIC	ELECTRIC	
	OIL TYPE	10W-30	10W-30	10W-30	10W-30	
	OIL CAPACITY	1.7	1.7	1.7	1.7	L
<b>BATTERY</b>						
	VOLTAGE	12	12	12	12	V
	Ah (20HR)	26	26	26	26	Ah
	CCA	280	280	280	280	A
<b>PUMP</b>						
	MODEL	WS252	T2535	W3523	W4518	
	OIL TYPE	15W-40	15W-40	15W-40	15W-40	
	OIL CAPACITY	1.1	1.2	1.2	1.2	L
<b>OTHER</b>						
	DETERGENT BOTTLE CAPACITY	-	-	-	-	L
<b>VALUES DETERMINED AS PER AS/NZS 60335.2.79</b>						
	SOUND PRESSURE LEVEL Lp	95	95	95	95	dB (A)
	UNCERTAINTY Kp	3.9	3.9	3.9	3.9	dB (A)
	SOUND POWER LEVEL Lw + UNCERTAINTY Kw	103	103	103	103	dB (A)
	REACTION FORCE ON SPRAY GUN	79.3	113.3	101.4	90	N
	REACTION TORQUE ON SPRAY GUN	24.4	34.9	0	0	Nm
	VIBRATION ON SPRAY GUN	3.25	3.5	3.95	3.5	m/s <sup>2</sup>
	UNCERTAINTY Kp	1.5	1.5	1.5	1.5	m/s <sup>2</sup>
<b>DIMENSIONS &amp; WEIGHT (UNPACK)</b>						
	LENGTH	771	771	771	823	mm
	WIDTH	508	508	508	508	mm
	HEIGHT	530	530	530	530	mm
	WEIGHT	86	114	114	114	Kg



*The manufacturer reserves the right to modify designs, features and technical data without notice.*

## DESCRIPTION OF SYMBOLS

The following symbols are used throughout this instruction booklet in order to mark important paragraphs or sections that require particular attention. Their meaning is listed next to them for your attention.

	<b>WARNING:</b> Failure to follow instruction could result in serious injury or even death		<b>WARNING:</b> Failure to follow instruction could result in damage to unit		<b>TIPS AND INSTRUCTIONS</b> to ensure safe and proper operation
	PERSONAL PROTECTIVE EQUIPMENT (PPE) Eye protection recommended		PERSONAL PROTECTIVE EQUIPMENT (PPE) Ear protection recommended		PERSONAL PROTECTIVE EQUIPMENT (PPE) Safety boots recommended
	PERSONAL PROTECTIVE EQUIPMENT (PPE) Respiratory protection		PRESSURE GAUGE		CHEMICAL INJECTOR OPEN / CLOSE
	OIL INDICATION		UNIT ON / OFF		VISUAL CHECK / VERIFICATION
	MANUAL ASSEMBLY		USE APPROPRIATE SPANNER		AUTHORIZED SPITWATER SERVICE AGENT

The following symbols are used on the unit in order to warn user of potential injury if not cautious. Their meaning is listed next to them for your attention.

	<b>CAUTION</b> Hot surface. Do not touch		<b>CAUTION</b> Electric shock hazard. Disconnect power before removing		<b>CAUTION</b> High pressure jet can be dangerous
---	--	---	--	--	--

	<p><b>IMPORTANT SAFETY INSTRUCTIONS AND PRECAUTIONS</b></p> <p><b>WARNING:</b> This high-pressure cleaner shall only be used by persons instructed in its use and who have been authorized to do so. Before using this high-pressure cleaner, please pay particular attention to the following safety warnings as failure to do so could result in serious injury or even death.</p>
---	--

# SAFETY LABELS, UNIT COMPONENTS FEATURES & CONTROLS



- Always pay attention to the safety instructions provided on each label. Do not alter or remove safety labels

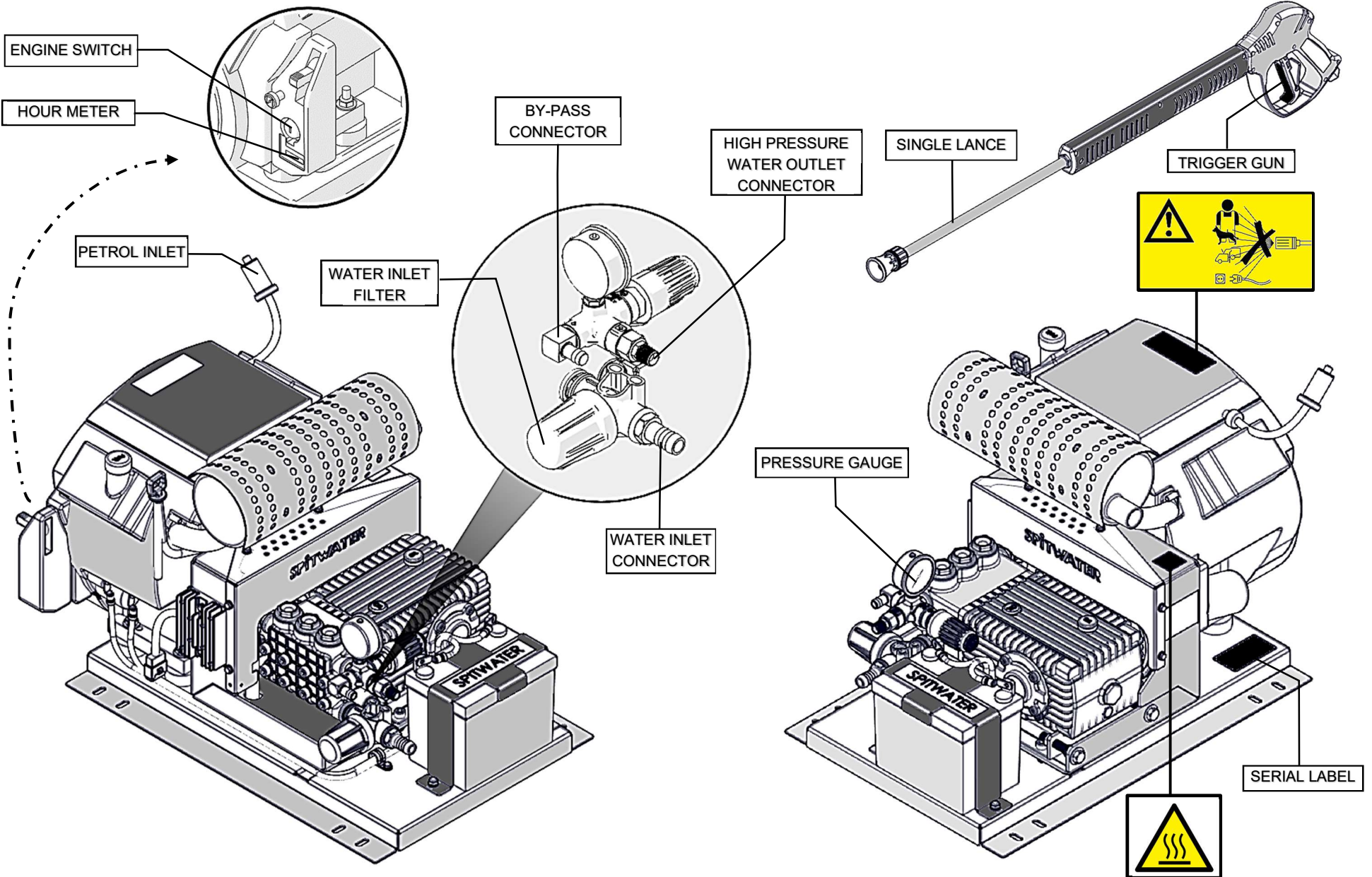

## GENERAL SAFETY PRECAUTIONS



### 1. OBSERVE SAFETY INSTRUCTIONS

- Make sure you have read and understood the whole instruction manual before installing, operating or carrying out any maintenance on this unit.
- Warnings and serial label on the unit provide important directions and information on the safe use of the unit.
- In addition to these operating and safety instructions please make sure that all accident prevention regulations applicable in the country of use are followed.
- In addition to these operating and safety instructions any standards relating to the installation and operation of high-pressure cleaners applicable in your country must be strictly followed.
- This unit is not intended for use by children. Children must always be supervised when in the vicinity and ensure that they DO NOT play with the unit.
- This unit is not intended for use by persons with reduced physical, sensory or mental capabilities, or lack of experience or knowledge. It must only be operated by persons instructed and trained in its use who have been especially authorized to do so.
- DO NOT operate the unit without appropriate personal protective equipment PPE.



### 2. ELECTRICAL CONNECTION (Electric units only)

- The voltage, hertz rating and number of phases on the serial label must correspond to that of the electrical mains outlet.
- Only connect the unit to electrical installation made by **certified electrician that complies with IEC 60364-1**.
- The electrical supply to this unit **MUST** include either a residual current device that will interrupt the supply if the leakage current to earth **exceeds 30mA for 30 ms** or a device that will prove the earth circuit.
- This Class 1 Appliance must only be connected to an earthed power supply fitted with an appropriately sized fuse.
- Always switch off the mains disconnecting switch when leaving the unit unattended.

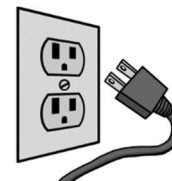

### 3. POWER CORD (Electric units only)

- Make sure before every use that the power cord assembly has no damage to it. If damage is present, DO NOT connect the unit, have it replaced by an electrician or authorized service technician. **(Type Y attachment)**
- DO NOT pull on the power cord in order to unplug the unit, remove the plug from the power outlet.

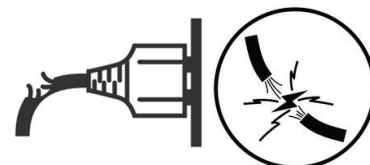



#### 4. EXTENSION CORD (Electric units only)

- If using an extension cord make sure it is according to cross section / maximum length requirements as shown to the right.
- Inadequate extension cords can be dangerous. If an extension cord is used, it shall be suitable for outdoor use, and the connection has to be kept dry and off the ground. It is recommended that this is accomplished by means of a cord reel which keeps the socket at least 60mm above the ground.
- Make sure the extension cord is fully unrolled, kept dry, away from traffic, sharp edges and heat to avoid damage or cuts.
- If using an extension cord make sure it is not connected to mains voltage when connecting / disconnecting to the unit's power cord.

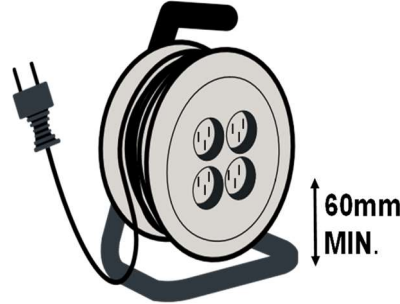

LENGTH	
0-10m	
<15A	2.5mm <sup>2</sup>
<25A	4.0mm <sup>2</sup>



#### 5. TRIP HAZARD

- Loose extension cords and power cables provide a potential trip hazard, especially when they cross pathways.
- Take safety measures like placing traffic cones along the cord or tape the cord to the floor with duct tape.

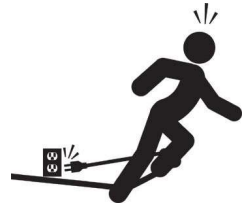

#### 6. FIRE PREVENTION AND HOT SURFACE CAUTION

- Store flammable fluids in approved containers and cabinets away from sparks and heat.
- To avoid fire, ensure there are no leaks of flammable liquids from fuel hoses.
- The muffler, chimney & other surfaces may be very hot. Take care not to touch these surfaces as they may burn your skin.
- To prevent a fire, do not expose dry grass, oil or any other combustible material to exhaust gas or other hot surfaces.
- Be sure to stop the unit before cleaning the unit.
- Under NO circumstance use flammable liquids, undiluted acids or solvents as the chemical, as the spray produced would be highly flammable and risks explosion.



#### 7. EXHAUST & FLUE GASES

- Do not use combustion engines or hot water units indoors unless adequate ventilation is present.
- Exhaust contains poisonous Carbon Monoxide; this can lead to unconsciousness or death if consumed due to inadequate ventilation. This applies to humans and animals.
- Ensure that any exhaust emissions are properly discharged and not in the vicinity of any air intakes.





## 8. SAFE HANDLING OF FUEL AND LUBRICANTS

- Always turn off the unit and let the unit cool down before refuelling and/or lubricating.
- DO NOT smoke or allow flames or sparks to be present whilst refuelling. Fuel is extremely flammable and explosive under certain conditions.
- Refuel in a well ventilated and open area. When fuel and/or lubricants are spilled clean immediately.
- DO NOT mix fuel. Incorrect fuels shall not be used as they may prove hazardous.
- Use only clean and approved fuel, stored in appropriate containers and dispensers.



## 9. CHEMICAL HAZARD

- In the event of accidental contact with cleaning detergent or oil, follow instructions provided by the manufacturer and/or product retailer and wash it off immediately with clean running water.
- Wear rubber gloves to avoid personal injury during chemical handling.
- If spillage occurs clean up immediately before using the unit.



**DANGER**  
Corrosive  
materials



Hand  
protection  
must be worn



## 10. CHECKS AND SERVICE

- The unit must always be switched off and disconnected from its power source before doing any maintenance.
- Inspect the unit each day before use. Follow “Daily inspection check list” guide *Table-B* in the SERVICE / CARE section.
- Service the unit regularly based on its usage. Follow “Usage vs Service frequency” matrix (*Table-A*) in the SERVICE / CARE section.



## 11. WATER SUPPLY

- Connection to potable water mains can be achieved by using a general garden hose set (1/2” diameter).
- Water that has flowed through backflow preventer is considered non-potable (non-drinkable).
- For suction supply / non-pressure water supply, other than potable water mains, contact your authorized Spitwater service agent for advice.

### **WARNING:**

- *This high-pressure cleaner is only allowed to be connected with the drinking water mains, when an appropriate backflow preventer has been installed, AS/NZS 60335.2.79.*
- *Follow all local standards and regulations applicable to water connection.*





## OPERATIONAL SAFETY PRECAUTIONS

All health and safety regulations applicable to general safe work practices, as well as safe operation of equipment, as well as any specific standard for safe operation of high-pressure cleaners according to local regulations must be followed.



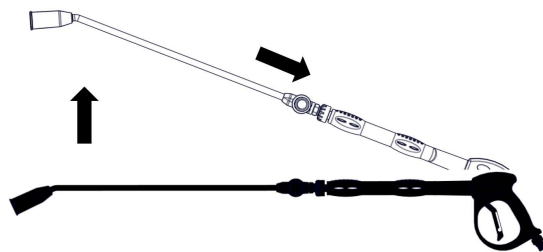

### 1. PERSONAL SAFETY

- Personal protective equipment (PPE) must be worn when operating this unit including footwear, clothing, eyewear and all other necessary equipment according to regulations and requirements.
- Always wear appropriate ear protection if the noise level indicated in the technical data of this appliance exceeds 80dB (A).
- When operating the unit be alert, hold onto the gun and lance firmly with both hands.
- When the gun is operated, the user is subject to very strong reaction force and torque.

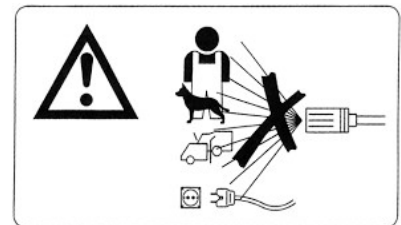

- There is a risk of high-pressure water jet injury. Never aim the jet at yourself, other people or animals as this could result in serious injuries or even death.
- Never direct the water jet at yourself or others in order to clean clothing or footwear.
- There is a risk of electrocution. Never aim the water jet at the unit itself or other live electrical equipment as this could result in serious injury or even death.
- Depending on the application of high-pressure cleaners, hydrous aerosols may be formed. The employer / operator shall perform a risk assessment in order to specify the necessary protective measures regarding aerosols depending on the surface to be cleaned and its environment. Shielded nozzles can be used for high pressure cleaning, which will reduce the emission of hydrous aerosols dramatically **OR respiratory masks of class FFP 2, an equivalent or higher are suitable for the protection against hydrous aerosols.**



-  **2. WORK ZONE SAFETY**
- The work zone must be kept clear of all persons not authorized to be there. If other people must be in the work area, they too must wear all necessary personal protective equipment and must be aware of the existing hazards / risks.
  - This unit must not be operated in hazardous areas. To prevent fire hazards, it must not be operated near flammables such as petrol, grain dust, solvents, thinners etc.
  - When operating the unit make sure the operating area is not releasing health or environmental hazardous substances (e.g., asbestos, oil etc.)

-  **3. EQUIPMENT SAFETY**
- The unit must be positioned on flat stable ground and must be in the upright position before operating. Do not operate on uneven surface or loose gravel.
  - Never operate the unit if there is any damage to components on the machine.
  - Never exceed the maximum working temperature and pressure as indicated on the unit data plate and in this manual.
  - Only use this unit with cleaning chemicals recommended by Spitwater. The use of other cleaning agents or chemicals may adversely affect the safety of the unit.
  - Never operate the unit without water as even a brief operation without it will cause severe damage to the pump and other components.
  - When finishing work, switch OFF the unit and release any trapped pressure in the hose and engage the gun trigger lock.
  - Never leave the unit unattended while it is running.
  - Never lock the spray gun trigger in the open position.
  - Never use hoses, accessories or spare parts that were not designed for use with this unit as this could cause damage to the unit. To ensure unit safety, only use original accessories and spare parts available through Spitwater and its extensive dealer network.
  - Never use a nozzle size other than that specified in the technical data. Using the wrong size nozzle could damage the unit.
  - Keep flammable materials away, and do not place anything on the unit while it is running.





## SAFETY FEATURES OF THE UNIT

**Safety valve:** This acts as a fail-safe system. When the system pressure exceeds the set value, the valve opens proportionally with increase in pressure and release the excess pressure out and resets back.



In case of EQUIPMENT FAILURE / BREAKDOWN turn the unit OFF and see “SERVICE / CARE RECOMMENDATIONS AND DIY TROUBLESHOOTING GUIDE” section.

## STORAGE, TRANSPORT & HANDLING

-  1. For safe movement of the unit between work areas make sure that the unit has been switched off. Allow it to cool down if necessary. Bleed any trapped pressure according to instructions and confirm all safety locks are engaged.
-  2. For safe transportation in and on vehicles make sure the unit is appropriately strapped, in order to prevent it from sliding or falling.
-  3. If transporting the unit make sure there is no possibility for the temperature to be at or below 0°C. If it is necessary to transport the unit at or below 0°C contact your authorized Spitwater service agent for advice.
-  4. When not in use the unit must be stored in a dry building where there is no possibility for the temperature to be at or below 0°C. If necessary to store the unit at or below 0°C contact your authorized Spitwater service agent for advice.
5. Keep detergent lines clean and flush regularly especially if the unit is not used often.
- 6.



**PROTECT FROM FROST**

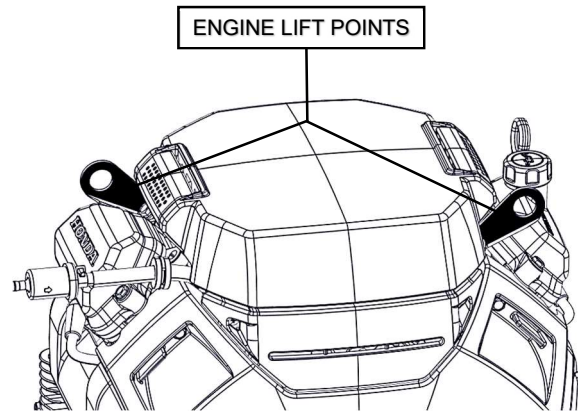

## ASSEMBLY & INSTALLATION GUIDE

1. Caution should be taken when lifting the unit. Always adopt safe lifting techniques in order to avoid damage to the unit and injuries to person.
2. Remove carton and carefully remove the unit from the pallet keeping it upright. Visually check for any damage, leaks or other issues. If any problem is found, contact your Spitwater agent immediately.
3. Identify the unit from the information on the serial label affixed to the unit.

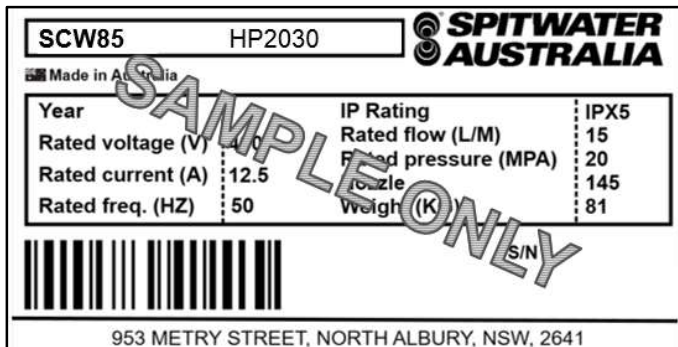

4. The unit must be positioned on flat stable support and must be in an upright position before operating. Do not operate on an uneven surface or without secure mounting.
5. The engine and exhaust become very hot during operation. Keep the unit at least 1metre (3 feet) away from buildings or other equipment during operation.

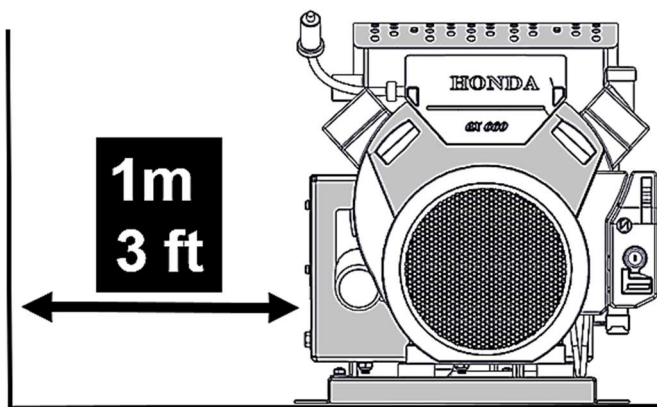

6. Mount the unit on the flat stable base by using at least four M10 bolts and washers. Refer to figure shown in point 13.
7. Replace the red oil travel plug fitted on the pump with the yellow dipstick supplied in the accessories bag.

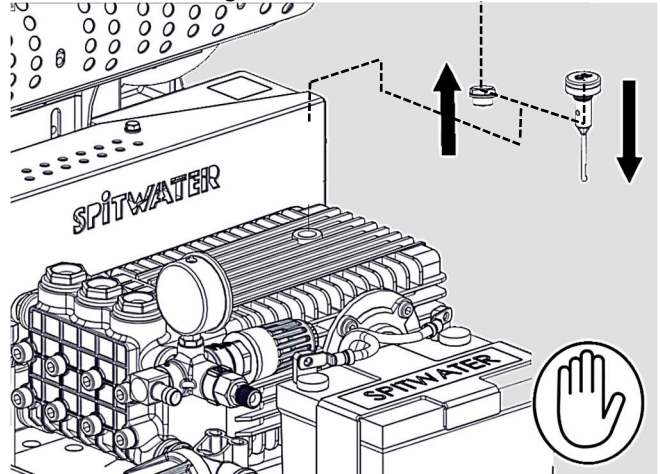

8. Check the oil level in the pump using the dipstick or the sight glass on the back / side of the pump. Make sure the level is between min/max level notches on the dipstick, or is level with the indicator on the sight glass. If oil reservoir needs replenishing only use oil of a type as listed in the data sheet in this instruction manual.

## 8. NOZZLE ASSEMBLY

Connect the high-pressure nozzle (smaller hole) and the low-pressure nozzle (larger hole) to the lance. Do not over tighten and make sure that the nozzle positions do not interchange during assembly. Add nozzle shield after nozzle assembly. Refer diagram below.

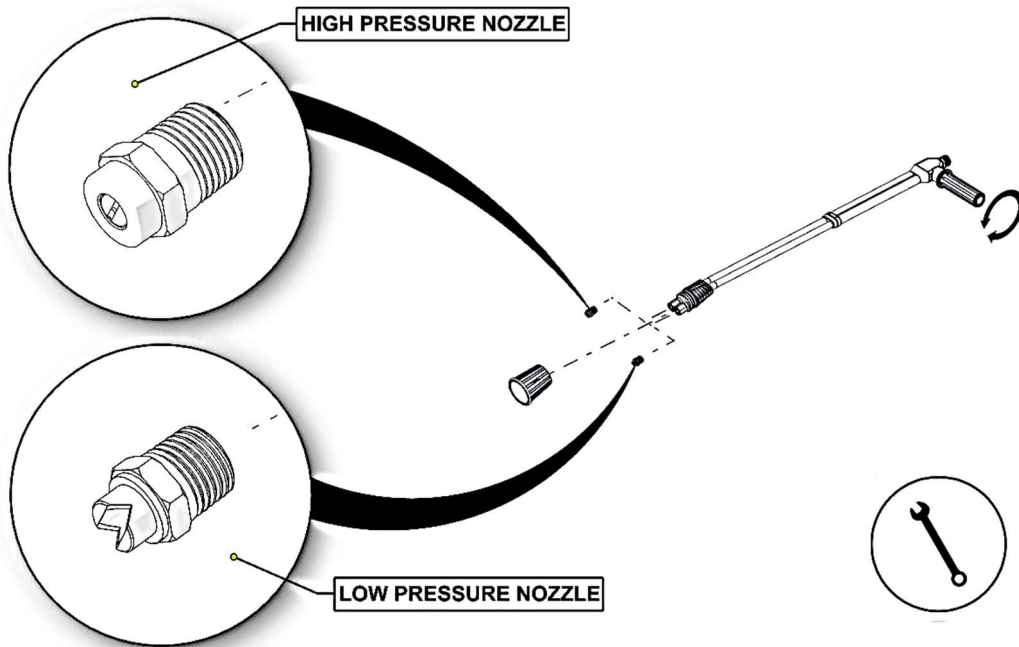

## 9. LANCE, TRIGGER GUN & HIGH-PRESSURE HOSE ASSEMBLY

- Connect the lance to the spray gun using quick release coupling.
- Connect the high-pressure hose fitting to the spray gun. Do not over tighten.
- Connect the quick release adaptor to the high-pressure hose fitting. Do not over tighten.

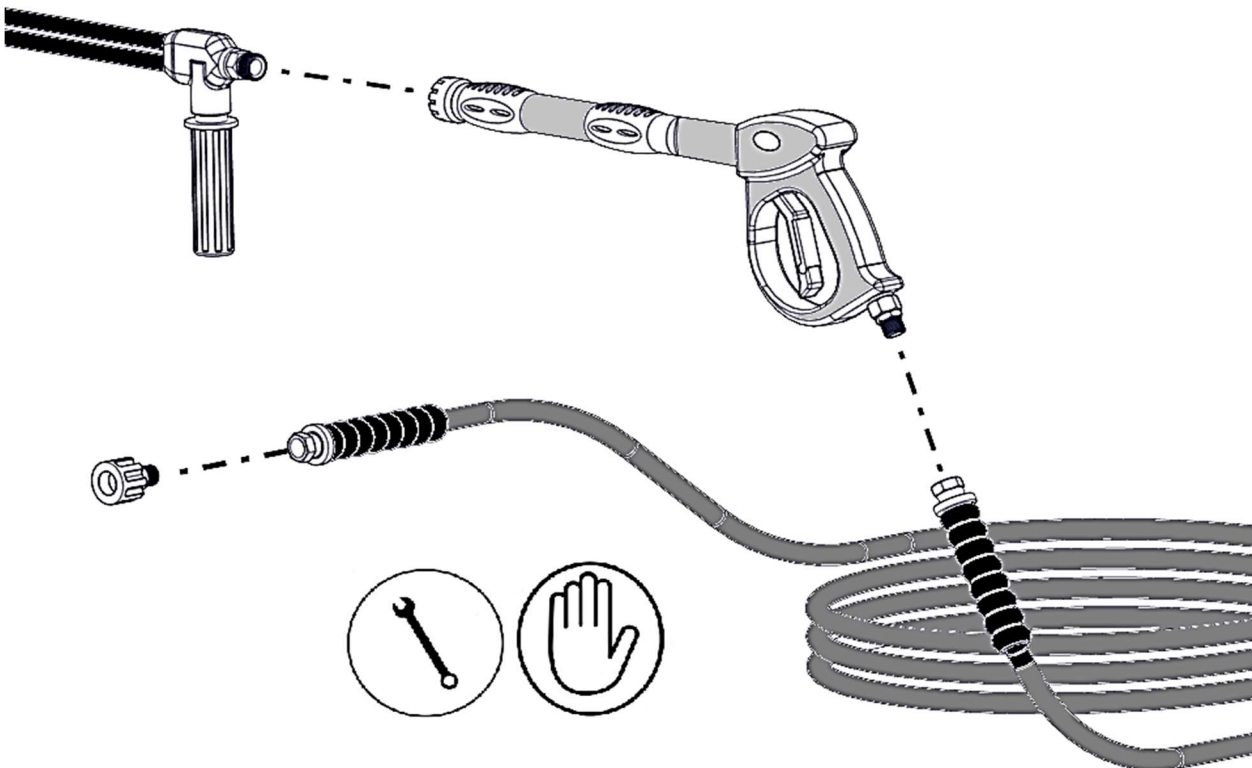

## 10. ASSEMBLY OF HIGH-PRESSURE HOSE WITH THE UNIT

- Connect the quick release high pressure hose to the outlet connector of the unit.

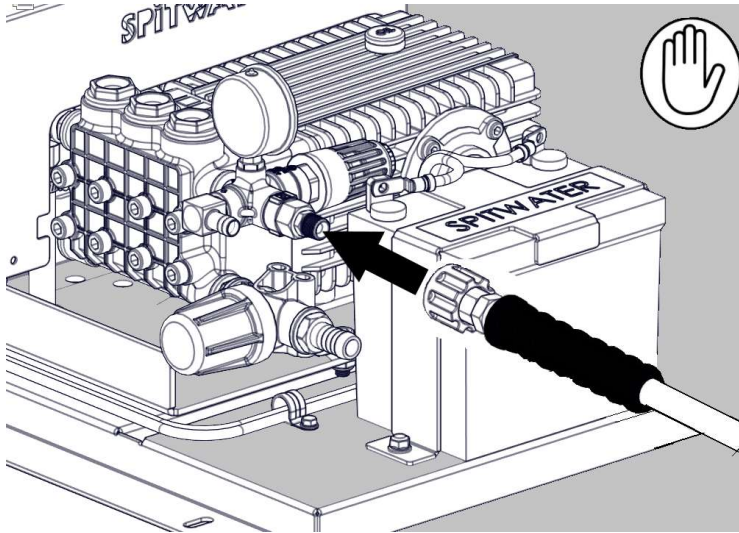

- High pressure hoses, fittings and couplings are important for the safety of the machine. Use only high-pressure hoses, couplings and fittings recommended by Spitwater.
- Do not pull-on high-pressure hose in order to move the unit.

## 11. WATER INLET CONNECTION

- Connection to potable water mains can be achieved by using a general garden hose set (3/4-inch diameter).
- Connect the water supply hose to the water inlet connection. In case of poor water quality, the use of an external water filter is recommended. Contact your Spitwater agent for advice and /or supply.
- Make sure the water supply temperature and pressure meet the values specified in the technical data, then turn the water supply on. Visually check for leaks and contact your Spitwater service agent if found.
- Open the water supply and fill the water tank. The float valve will automatically stop the water flow when the water tank is full.
- Water that has flowed through backflow preventer is considered to be non-potable (non-drinkable).
- For suction supply / non-pressure water supply, other than potable water mains, contact your authorized Spitwater service agent for advice.

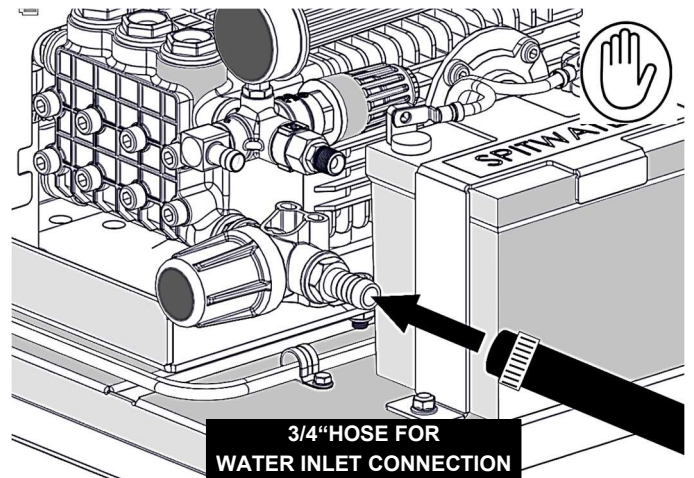
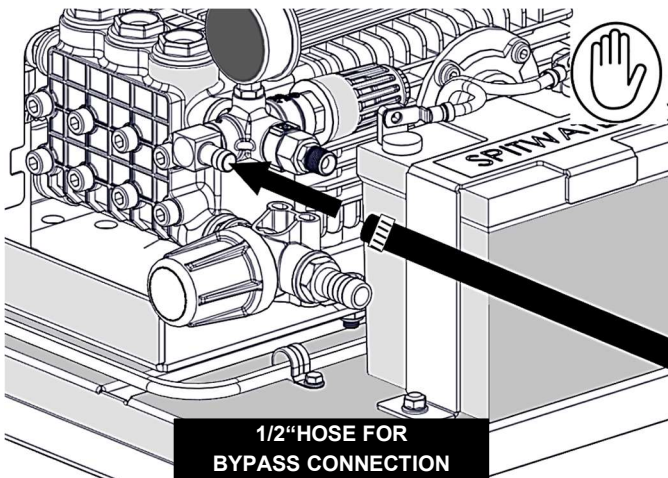

**WARNING:** This high-pressure cleaner is only allowed to be connected with the drinking water mains, when an appropriate backflow preventer has been installed, as per AS/NZS 60335.2.79. Follow all local standards and regulations applicable to water connection.

12. Connect the petrol tank/source to the fuel filter of the engine. **ONLY USE CLEAN PETROL IN THIS UNIT,** as using any other fuel will create a risk of explosion and damage to the unit.

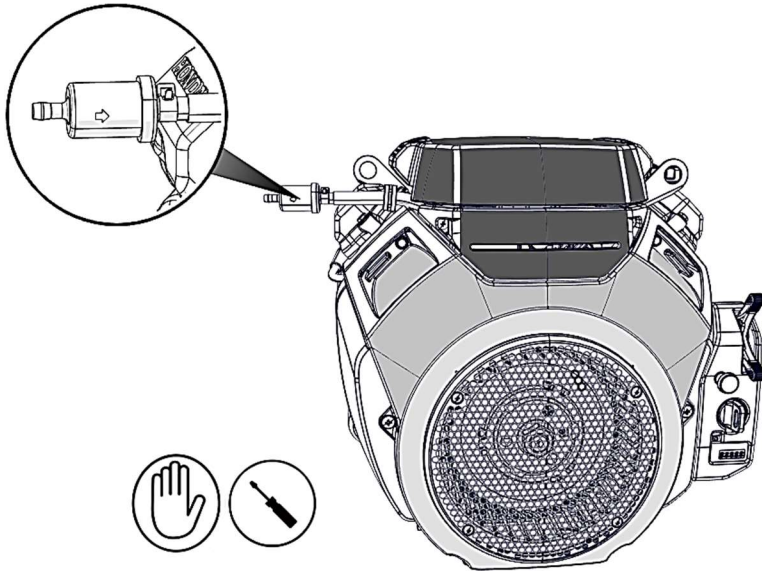

13. Base plate dimensions for mounting.

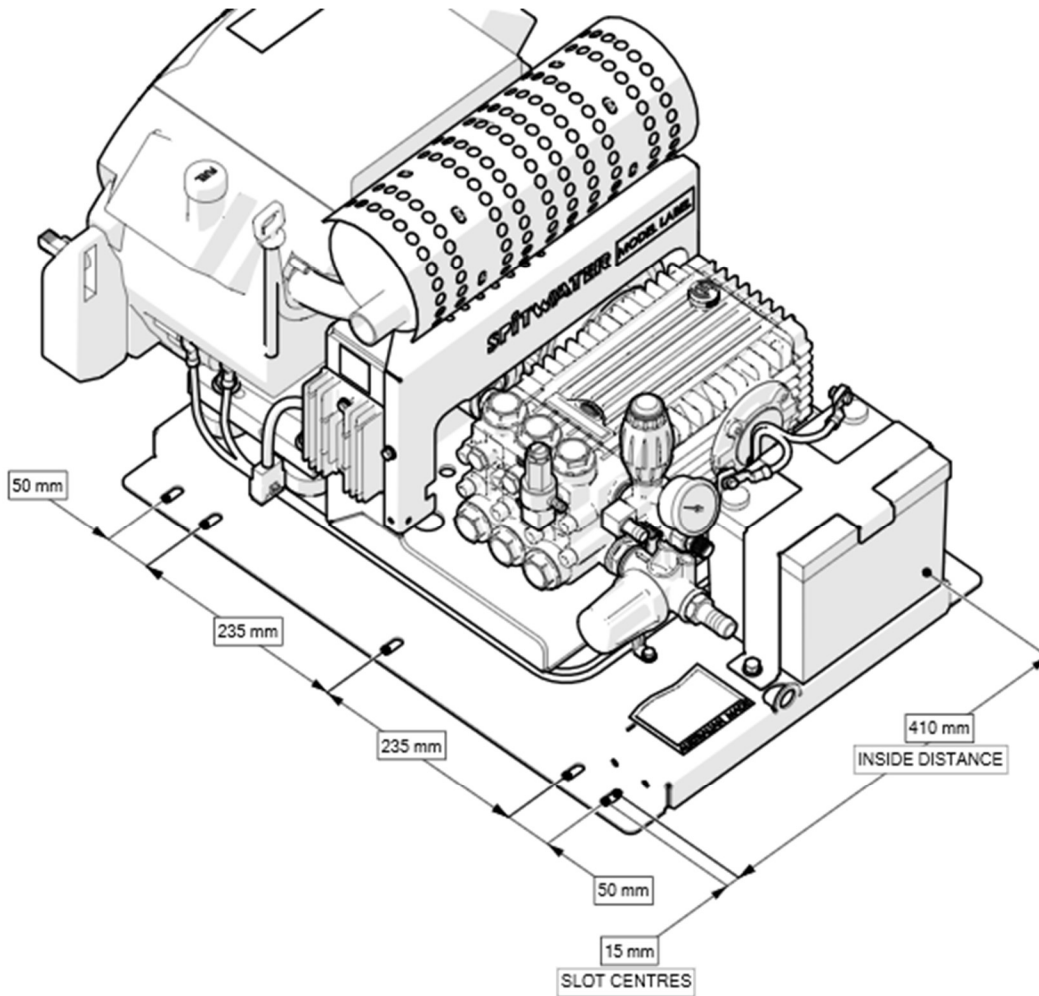



## OPERATING INSTRUCTIONS

### GENERAL PRE-START CHECK

1. Inspect the unit every day to confirm that it is safe and in proper working order before putting it into service. Follow the “**DAILY INSPECTION CHECK LIST**” in the SERVICE / CARE section as a guide. If the unit is damaged or faulty in anyways, DO NOT use it and immediately contact your authorized Spitwater service agent for advice.

### TO START

1. Always wear appropriate Personal Protective Equipment. (PPE)



2. Turn the engine switch to the START position, and hold it there until the engine starts. When the engine starts, release the engine switch, allowing it to return to the ON position.

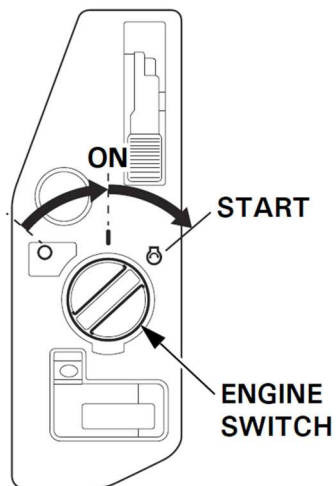

### NOTE:

- If the engine fails to start within 5 seconds, release the engine switch and wait at least 10 seconds before operating the starter again.
- Using the electric starter for more than 5 seconds at a time will overheat the starter motor and can damage it.

### COLD START

1. To start a cold engine, pull the choke knob to the CLOSED position and follow the regular engine start procedure. (Point-3)
2. After engine start, warm up the engine for 2 or 3 minutes.
3. Gradually push the choke knob to the OPEN position as the engine warms up.

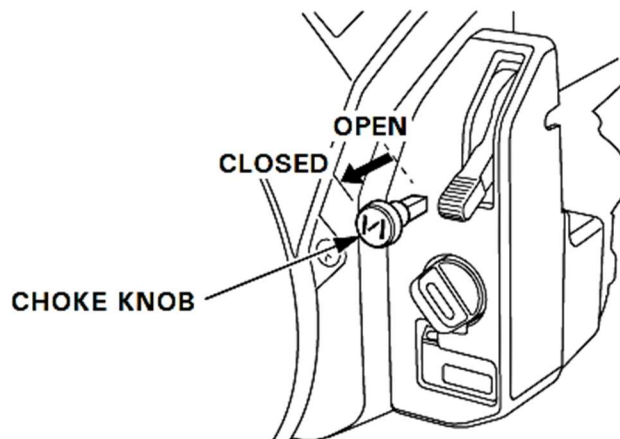

Refer HONDA instruction booklet enclosed for detailed cold start information.

### TO USE

1. Release the spray gun trigger lock.
2. Pull the trigger on the spray gun and allow water to run through the system for a few minutes to expel air from the hydraulic system. If air remains in the system, open and close the spray gun a few times to expel. **Note:** *If this is the first use of the unit or the unit has been left idle for an extended period of time it is advisable to run this operation with the front part of the lance disconnected in order to avoid debris or scale being lodged in the nozzle and blocking it.*



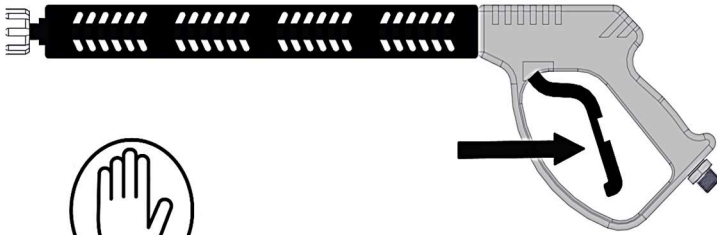

3. Check that the pressure indicated on the pressure gauge matches the value on the data plate and in the technical data. Also check that when the trigger is released the pressure shown on the gauge returns to zero.

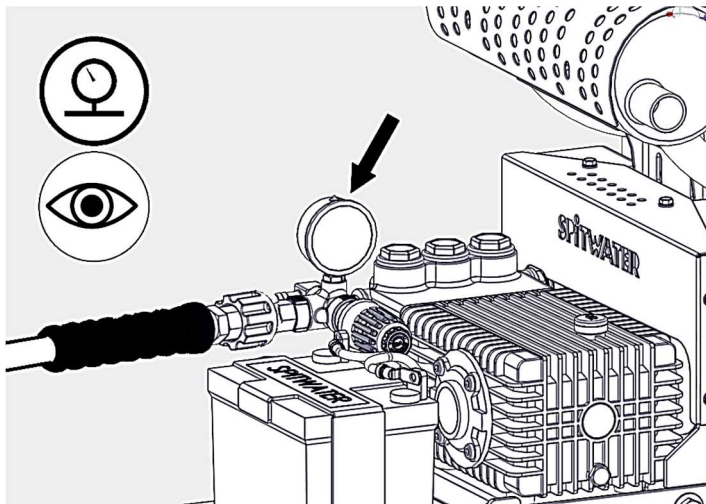

**USAGE TIPS:**

- Use the unit as necessary to carry out cleaning while trying to minimize where possible opening and closing the spray gun trigger as this will lead to premature wear of the parts.
- Do not hold the nozzle too close to the surface to be cleaned as this may damage the nozzle. Start cleaning at a comfortable distance and work closer as necessary.

**TO STOP**

1. Turn the engine switch to the OFF position.

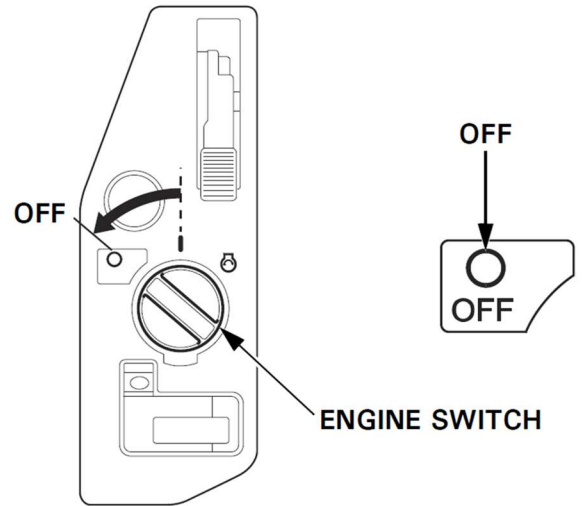



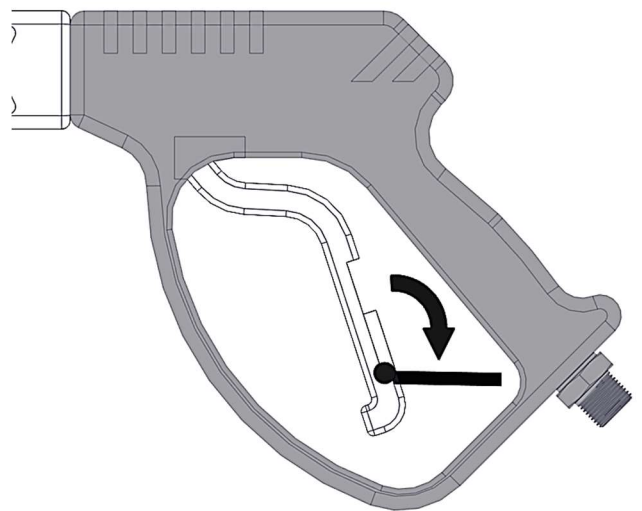



2. Release all trapped water pressure in the unit by pulling the trigger of the spray gun, then engage the spray gun trigger lock. Failure to follow this instruction will leave the unit in a potentially unsafe manner.





## SERVICE / CARE RECOMMENDATIONS AND DIY TROUBLESHOOTING GUIDE

### SAFETY PRECAUTIONS

-  1. To ensure machine safety, use only original spare parts from the manufacturer or approved by the manufacturer.
-  2. Carry out all regular maintenance and inspections as listed in this manual using original Spitwater parts where required.
-  3. Always make sure before carrying out any maintenance that the unit is turned off, allowed to cool down and any trapped high pressure in its system has been released.
-  4. Never carry out any maintenance work not specifically outlined in this booklet and never make any technical modifications to this unit.
-  5. This unit is fitted with safety devices which are set and sealed at the factory. It is very important these devices receive their routine maintenance to assure your safety as well as necessary protection of the unit.
-  6. There are a number of important components that have been set and sealed at the factory. Never under any circumstances tamper with, modify or adjust these settings.
-  7. Make sure this unit is regularly serviced by an authorized Spitwater service agent according to the servicing requirement outlined in this booklet.

### SERVICE INSTRUCTIONS

To maintain this unit in peak working condition during its operating life it is necessary to carry out regular maintenance operations and replace worn or broken parts immediately upon their failure. Spitwater recommends that all maintenance is carried out by an authorized Spitwater service agent using original Spitwater spare parts.































Failure to follow the maintenance guidelines in this manual, releases the manufacturer from any responsibility in reference to injuries and damages to both persons and

**DANGER**  
**HAZARDOUS CHEMICALS**

**Always dispose of oil, batteries, chemicals and unused equipment safely and according to the requirements of local authorities**

# DAILY INSPECTION CHECK LIST

CHECKED & OK		
ATTENTION REQUIRED		
CHECKS BEFORE STARTING UNIT		
		Ensure all guards and covers are in place & unit appears in good condition
		Clean off excessive dust or foreign matter that could disrupt normal operation
		Check power cable & plug for any damage (If applicable)
		Check for water leaks at supply inlet and other hose connections
		Check high pressure hose for kinks and damage, do not use if hose in poor condition
		Check fuel level, detergent level, detergent hose etc
		Check engine oil level (If applicable)
		Check pump oil level
		Check pump oil colour has not gone 'Milky' in appearance
		Check service interval, you may be due for the next service
CHECKS WHILST USING THE UNIT		
		Check pressure gauge shows rated pressure according to serial label
		Check for water leaks at high pressure connections
		Check exhaust fume colour, if dark there may be an issue
		Check for any unusual noises from the machine

	Safe to use		Contact Spitwater service for assistance
	Ok to fix this yourself		<b>STOP</b> , do not operate unit. Contact Spitwater service immediately

TABLE-B: Daily inspection checklist

## USAGE VS SERVICE FREQUENCY

	<b>MORE THAN 6 TO 8 HOURS DAILY</b>	<b>SERVICE ONCE EVERY</b>	<b>1</b> <b>Month</b>
	<b>4 TO 6 HOURS DAILY</b>	<b>SERVICE ONCE EVERY</b>	<b>3</b> <b>Months</b>
	<b>WEEKLY USE</b>	<b>SERVICE ONCE EVERY</b>	<b>6</b> <b>Months</b>
	<b>INFREQUENT or MONTHLY USE</b>	<b>SERVICE ONCE EVERY</b>	<b>12</b> <b>Months</b>



*Time interval for checks and replacement listed above are for units subjected to normal operating conditions. Should the unit be subjected to abnormal conditions (e.g., heavy use, dirty water, extreme temperatures or conditions etc.) times should be reduced accordingly.*

TABLE-A: Usage vs Service Frequency

# OIL CHECK POINTS

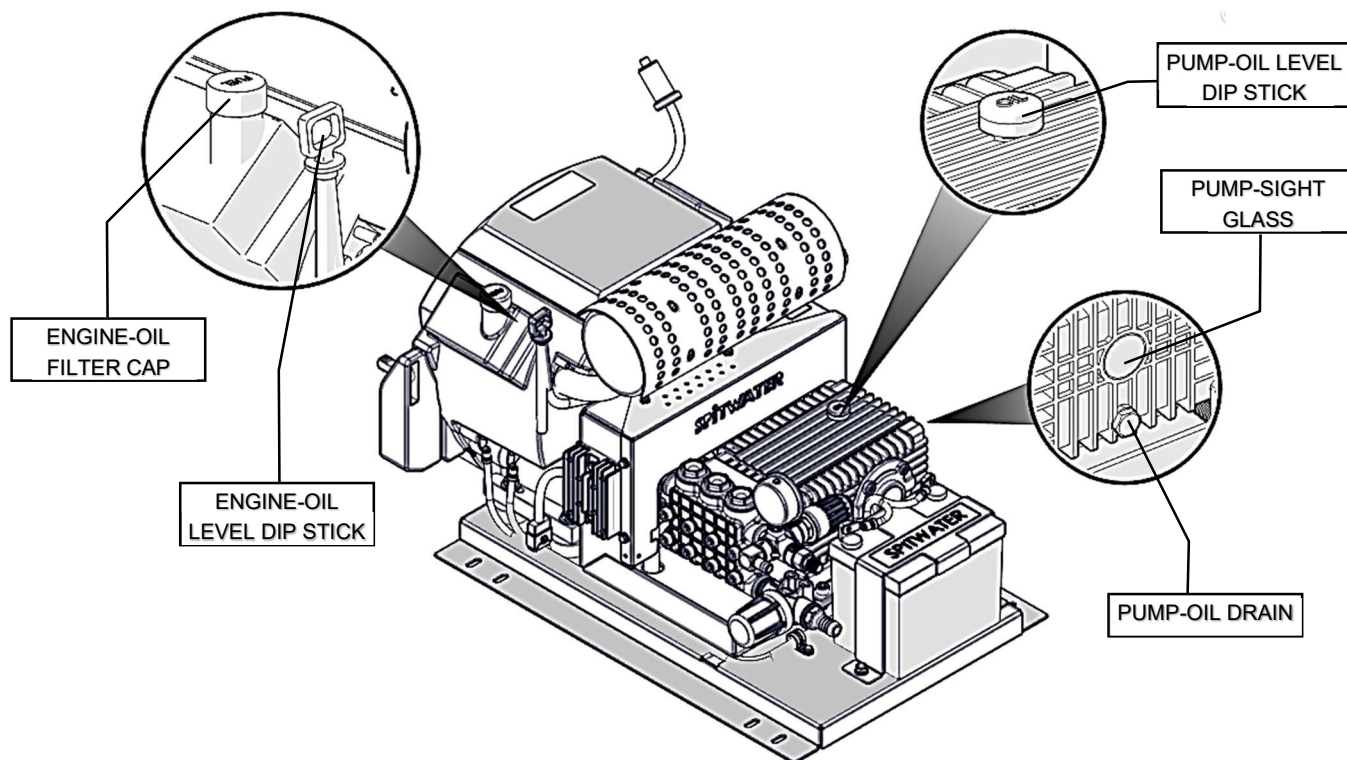

## ENGINE OIL CHECK

Ensure the unit is on a flat surface.

Remove the oil level dipstick and wipe it clean.

Fully insert the oil level dipstick, and then remove it to check the oil level.

Acceptable oil level is between upper and lower limit.

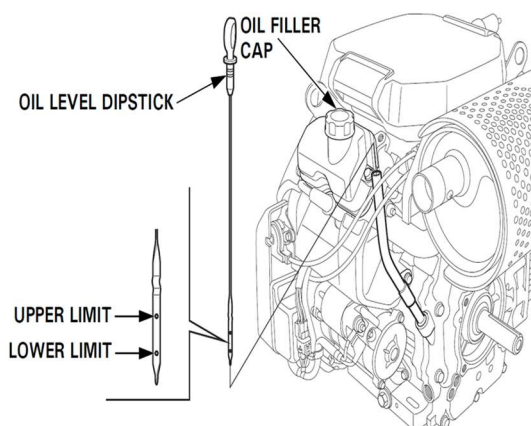

## PUMP OIL CHECK

Ensure the unit is on a flat surface.

Check the oil level in the pump using the dipstick or the sight glass on the back / side of the pump. Make sure the level is between min/max level notches on the dipstick, or is level with the indicator on the sight glass

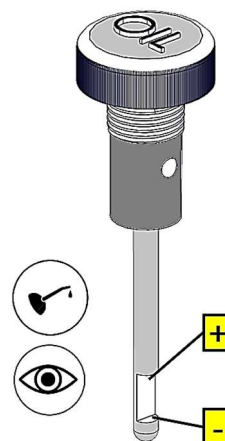

## TROUBLESHOOTING GUIDE



*If the fault cannot be identified or corrected using the below list (or remedy suggests contacting Spitwater service agent) stop using the unit immediately and contact your authorized Spitwater service agent to rectify.*

TROUBLESHOOTING GUIDE		
FAULT	CAUSE	REMEDY
Pump is running but does not reach rated pressure	Pump sucking air	Check hose / fittings for leaks
	Nozzle is blocked / worn	Remove and clean nozzle
	Water filter dirty	Check and clean water filter
Fluctuating pressure	Pump sucking air	Check hose / fittings for leaks
	Nozzle is blocked / worn	Remove and clean nozzle
	Water filter dirty	Check and clean water filter
Pump is noisy	Pump sucking air	Check hose / fittings for leaks
Appearance of "milky" oil in the pump		Contact Spitwater service agent
Water leaking from pump		Contact Spitwater service agent
Oil leaking from pump		Contact Spitwater service agent
Engine does not start (If applicable)	Check fuel	Add fuel
	Low level water (if fitted)	Turn water supply on
	Unknown	Contact Spitwater service agent
The motor does not start when switch is activated. (Electric units only)	Plug is not connected.	Check the plug.
	Low level water (if fitted)	Check that water / diesel tank are full and add water / diesel as necessary.
	No power supply.	Contact an authorized electrician to check power supply.
When switch is activated the motor hums but does not run. (Electric units only)	Incorrect extension cable.	See instructions in manual and replace with an extension cord of correct size and length.
	Incorrect or insufficient voltage or amperage.	Contact an authorized electrician to check power supply.
	Failed capacitor	Contact Spitwater service agent



*For service of your Spitwater high pressure cleaner within Australia, call **1800SPITWATER** or visit **[www.spitwater.com.au](http://www.spitwater.com.au)** for further contact details.*